

ALEA

Regaso



Pegaso era il celebre cavallo alato della mitologia greca generato dalla gorgone Medusa. Divenne il cavallo dell'eroe Perseo che aiutò nell'impresa contro la Chimera. Alla fine delle sue vicende, Pegaso venne trasformato da Zeus nell'omonima costellazione.

All'immagine del cavallo alato e della costellazione si associano concetti quali leggerezza e luminosità: sono argomenti che ritroviamo nelle ambientazioni realizzate con la linea Pegaso.

Accordingly to the Greek mythology, Pegaso was the famous winged horse created from Medusa the Gorgon. Pegaso became hero Perseus' horse and helped him to defeat the Chimera. At the end of his adventures, Pegaso was turned by Zeus into a constellation named "Pegaso".

The image of the winged horse and the constellation evoke lightness and brightness: the features we rediscover in the Pegaso series

Pegaso (ndt. Pégase en français) était le célèbre cheval ailé de la mythologie grecque, fils de la Méduse Gorgone. Il devint le cheval du héros Persée qu'il aida dans sa lutte contre la Chimère. À la fin de ses exploits, Pégase fut transformé par Zeus en une constellation qui porte son nom.

À la légende du cheval ailé et de la constellation, nous pouvons associer des concepts tels que légèreté et luminosité que nous retrouvons dans les agencements réalisés avec les meubles de la ligne Pegaso.

Pegaso es el célebre caballo alado de la mitología griega generado por la Gorgona Medusa. Se convirtió en el caballo del héroe Perseo, a quien ayudó en su lucha contra la Quimera. Al final de sus aventuras, Zeus lo transformó en la constelación que lleva su nombre.

A la imagen del caballo alado y de la constelación, se asocia una idea de ligereza y luminosidad, aspectos que encontramos en todos los ambientes realizados con la línea Pegaso.

Pegasus, das berühmte geflügelte Pferd aus der griechischen Mythologie; erschaffen von der furchtbaren Medusa. Es wurde das Pferd des Helden Perseus und unterstützte ihn bei seinen Heldentaten gegen die Chimäre. Am Ende der Geschichte wird Pegasus von Zeus in das gleichnamige Sternbild verwandelt. Das Bild des geflügelten Pferdes und des Sternbildes werden mit Leichtigkeit und Helligkeit assoziiert: Themen und Attribute, die wir im Einrichtungskonzept der Linie Pegasus wieder finden.

design:

Filippon &
Mirto Antonei







Pegaso di ALEA si propone come sistema operativo ad alto contenuto tecnologico e interpreta la richiesta di razionalità dell'ufficio moderno grazie ad un design essenziale e rigoroso.

La struttura di sostegno è realizzata con gambe in tubolare metallico di sezione rettangolare elettrosaldato e verniciato, giuntate tra loro da traversi in tubolare metallico. Le gambe sono dotate di carter verticale asportabile che ne rende attrezzabile l'interno per il raccoglimento dei cavi.

Pegaso, with its graceful and clear-cut design, is a high tech system for stylish and functional office solutions. The series comes with a robust and well integrated structure made of electro-welded and varnished tubular metal legs with rectangular cross-section, joined by tubular metal bars. In addition to its structural function, the leg has also been designed to house a considerable number of cables through a removable pop out insert.

Pegaso d'ALEA se présente comme un système opérationnel avec un haut contenu technologique et interprète la demande de rationalité du bureau moderne grâce à un design simple et rigoureux. Le piètement est réalisé avec des pieds en tube métallique rectangulaire électro-soudé et laqué, assemblés entre eux à l'aide de traverses en tube métallique. Les pieds sont dotés d'un carter vertical amovible dont l'intérieur peut être aménagé pour accueillir les câbles.

Pegaso de ALEA se presenta como un sistema operativo de alto contenido tecnológico e interpreta la exigencia de racionalidad de la oficina moderna con un diseño esencial y riguroso. La estructura de soporte está realizada con patas de tubo metálico de sección rectangular electrosoldado y barnizado, unidas entre sí por travesaños de tubo metálico. Las patas están dotadas de un cárter vertical extraíble que permite equipar su interior para recoger los cables.

Pegasus von ALEA wurde als System mit hohem technologischem Anspruch konzipiert und stellt sich den Ansprüchen an die Zweckmäßigkeit eines modernen Büros dank seines nüchternen und strengen Designs. Für die Trägerstruktur wurden Beine aus elektrogeschweißten und lackierten Metallrohren mit rechtwinkligem Querschnitt verwendet, die untereinander mit Querstreben aus Metallrohren verbunden sind. Die Beine verfügen auf der Innenseite über eine vertikale abnehmbare Abdeckung, die ein Verlegen der Kabel im Fußinneren erlaubt.

















I piani lavoro di spessore 18 mm sono disponibili nelle finiture melaminiche Bianco Rigato, Grigio Rigato, Rovere Chiaro e Rovere Scuro che si possono ritrovare anche a rivestimento dei contenitori. Colorati pannelli divisorii contribuiscono ad arricchire le soluzioni cromatiche a disposizione. Sportelli di elettrificazione orizzontale possono essere all'occorrenza inseriti tra piano e pannelli divisorii.

The thickness of the desktop is 18 mm (11/16"). They come in melamine Ribbed White, Ribbed Grey, Light Oak and Dark Oak. The same finishes are available for the complementary storage units. Screens as well come with different colours adding finishes to the series.

Les plateaux de bureau de 18 mm d'épaisseur sont déclinés dans les finitions mélaminées suivantes : blanc strié, gris strié, décor chêne clair, décor chêne foncé. Ces teintes sont également disponibles pour le revêtement des meubles. Des cloisons colorées contribuent à enrichir les solutions chromatiques à disposition. Les couvercles de l'électrification horizontale peuvent, si nécessaire, être insérés entre le plateau de bureau et les cloisons.

Las superficies de trabajo de 18 mm de grosor están disponibles en los acabados melamínicos Blanco rayado, Gris rayado, Roble claro y Roble oscuro, que también pueden emplearse para revestir los contenedores. Los paneles separadores de colores enriquecen las soluciones cromáticas disponibles. Siempre que se considere oportuno, entre la superficie y los paneles separadores pueden incorporarse puertas de electrificación horizontal.

Die Melamin beschichteten Arbeitsflächen mit einer Plattenstärke von 18 mm werden in den Ausführungen weiß liniert, grau liniert, Eiche hell und Eiche dunkel angeboten. Diese Ausführungen finden sich auch bei den Schrankelementen wieder. Farbige Sichtschutzpaneele der Schreibtische bereichern die zur Verfügung stehenden farblichen Lösungen. Waagerechte verdeckte Steckdosenleisten können im Bedarfsfall zwischen Arbeitsfläche und Sichtschutzpaneel eingesetzt werden.





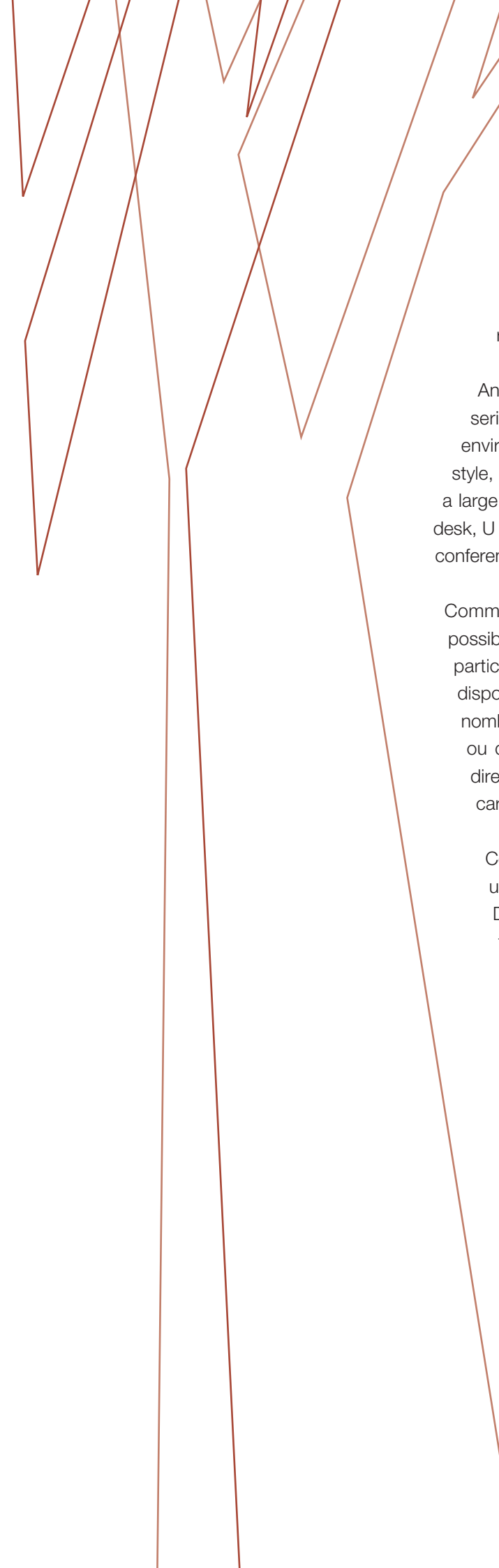

In alternativa ai contenitori ad ante battenti è possibile utilizzare i contenitori ad ante scorrevoli della serie Dedalo, particolarmente adatti ad ambienti lavorativi con poco spazio a disposizione. La semplicità strutturale del sistema consente molte configurazioni diverse: dalle postazioni operative contrapposte a quelle più complesse realizzate in sequenza, da soluzioni direzionali semplici ed eleganti a tavoli riunione quadrati o rettangolari.

An alternative to storage units with hinged doors, is the storage series with sliding doors (Dedalo collection), very suitable for work environments with limited space. In addition to the aesthetics and style, Pegaso has been designed to be a multi functional series and fit a large variety of solutions: from the basic freestanding desk to L shape desk, U shape desk, cluster of stations side to side or/and front to back to conference tables.

Comme solution alternative aux meubles à portes battantes, il est possible d'utiliser les meubles à portes coulissantes de la série Dedalo, particulièrement adaptés aux lieux de travail qui ont peu d'espace à disposition. La simplicité structurale du système permet de réaliser de nombreuses configurations proposant des postes de travail individuels ou des postes plus complexes réalisés en séquence, des solutions directionnelles simples et élégantes ou encore des tables de réunion carrées ou rectangulaires.

Como alternativa a los contenedores de puertas batientes, pueden utilizarse los contenedores de puertas correderas de la serie Dedalo, particularmente indicados en ambientes laborales que tienen poco espacio. La sencillez estructural del sistema permite crear numerosas configuraciones diferentes: desde las estaciones operativas contrapuestas hasta las realizadas en secuencia de mayor complejidad, desde soluciones direccionales simples y elegantes hasta mesas de reunión cuadradas o rectangulares.

Alternativ zu den Schrankelementen mit Drehtüren können auch Schiebetürschränke der Serie Dedalo verwendet werden, die besonders empfehlenswert in einem Arbeitsumfeld mit geringem Platzangebot sind. Die einfache Struktur des Systems erlaubt viele verschiedene Zusammenstellungen. Die Elemente können einfach gegenüberstehend aufgestellt werden, komplexer hintereinander aber auch für die Einrichtung von Chefzimmern verwendet werden – einfach und elegant ebenfalls in Konferenzräumen mit quadratischen oder rechteckigen Tischen.









I tavoli Pegaso sono dotabili di sportelli di accesso a doppio verso di apertura che consentono un rapido collegamento all'alimentazione elettrica e alla rete informatica.

As shown in the pictures, Pegaso provides an easy and quick connection to the electrical power supply and IT network.

Les tables Pegaso peuvent être équipées de trappes d'accès à double sens d'ouverture qui permettent une connexion rapide au réseau électrique ou informatique.

Las mesas Pegaso pueden estar dotadas de puertas de acceso con doble dirección de abertura, que permiten una rápida conexión a la alimentación eléctrica y a la red informática.

Die Tische der Linie Pegasus verfügen über eine Steckerleiste mit wechselseitige öffnender Klappe, die einen schnellen kurzen Zugang zu den Steckern für die Stromversorgung und das Datennetz erlaubt.

























I tavoli riunione Pegaso offrono diverse opzioni dimensionali e tipologiche e possono essere opportunamente cablati per alimentare accessori quali portatili e lampade da tavolo. L'abbinamento con i contenitori ad ante scorrevoli Dedalo conferisce all'ambiente eleganza e funzionalità. Gli elementi d'arredo di Pegaso costruiscono l'architettura dei luoghi di lavoro. Un sistema facilmente plasmabile in base alle esigenze operative ed estetiche dell'ambiente che lo ospita.

Pegaso conference tables, available in a variety of shapes and sizes, can be accessorized with powered flip tops for laptops and table lamps connections. When combined with Dedalo storage units with sliding doors Pegaso becomes even more elegant and functional. Its furnishing elements add design to the workplace. Their versatile features also suit the operating and aesthetic requirements of the work environment they furnish.

Les tables de réunion Pegaso offrent différentes options au niveau des dimensions et des formes et peuvent être adéquatement câblées pour alimenter des accessoires tels que ordinateurs portables ou lampes de table. L'utilisation des meubles à portes coulissantes Dedalo donne à l'agencement élégance et fonctionnalité. La ligne Pegaso construit l'architecture des lieux de travail. Un système facilement adaptable en fonction des besoins opérationnels et esthétiques des locaux qui l'accueillent.

Las mesas de reunión Pegaso ofrecen distintas opciones dimensionales y tipológicas y pueden cablearse convenientemente para alimentar accesorios como portátiles y lámparas de mesa. Su combinación con los contenedores de puertas correderas Dedalo aporta elegancia y funcionalidad en el ambiente de trabajo. Los elementos de Pegaso construyen la arquitectura de los lugares de trabajo. Un sistema fácil de plasmar en función de las exigencias operativas y estéticas del ambiente que lo aloja.

Die Konferenztische der Linie Pegasus bieten verschiedene Optionen bezüglich Maße und Typ und können angemessen verkabelt werden, um eine Anbindung von tragbaren Geräten sowie die Stromversorgung von Tischlampen zu gewährleisten. Die Zusammenstellungen mit den Schrankelementen mit Schiebetüren der Linie Dedalo verleihen dem Arbeitsambiente einen eleganten und funktionellen Touch. Die Einrichtungselemente von Pegasus gestalten die Architektur des Arbeitsplatzes – ein System, das leicht angepasst werden kann und den Bedürfnissen nach Zweckmäßigkeit und Ästhetik des Arbeitsambientes gerecht wird.









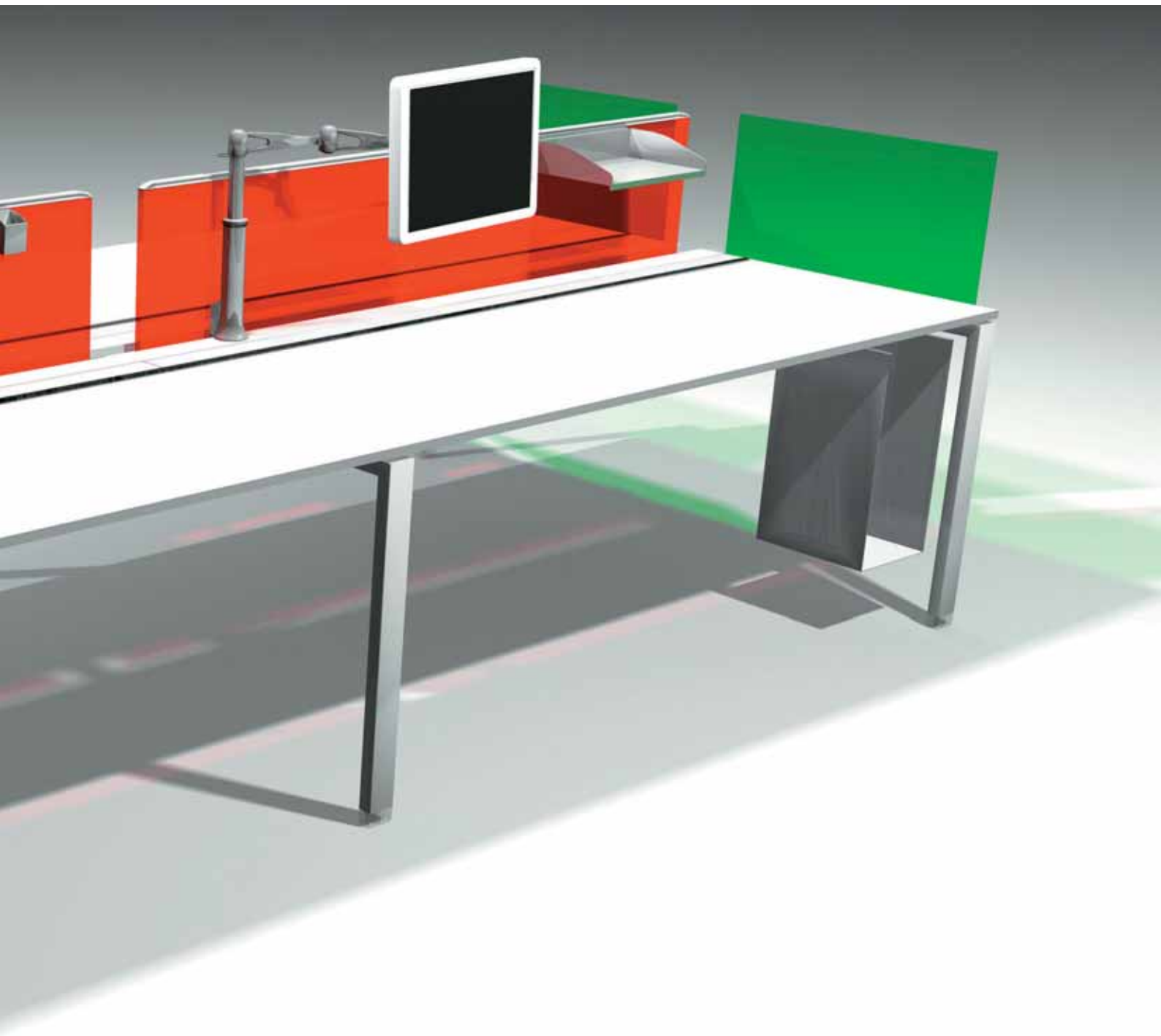

1



Sistema scrivania/dattilo
agganciato

*Typical configuration of desk
and hanging return*

*Schéma système de montage
bureau + retour accroché*

Sistema mesa / ala unida

*Montageanleitung
des Schreibtisches
+ des Winkelbautisches*

2



Schema sistema
di aggregazione

*Typical configuration
of extending desk*

*Schéma système de montage
bureau + rallonge*

*Esquema sistema
de agregacion*

*Montageanleitung
des Schreibtisches
und der Verlängerung*

3



Schema porta CPU - screen frontale

Screen and CPU holder arrangement

Schéma système de montage support U.C. et panneau écran frontal

Esquema porta cpu – panel frontal

Montageanleitung des CPU-Halters und des Sichtschutzpaneels

4



Schema dettaglio elettrificazione

Typical cable management configuration

Schéma détail électrification

Esquema detalle electrificacion

Plan des Elektrifizierungsystems

5

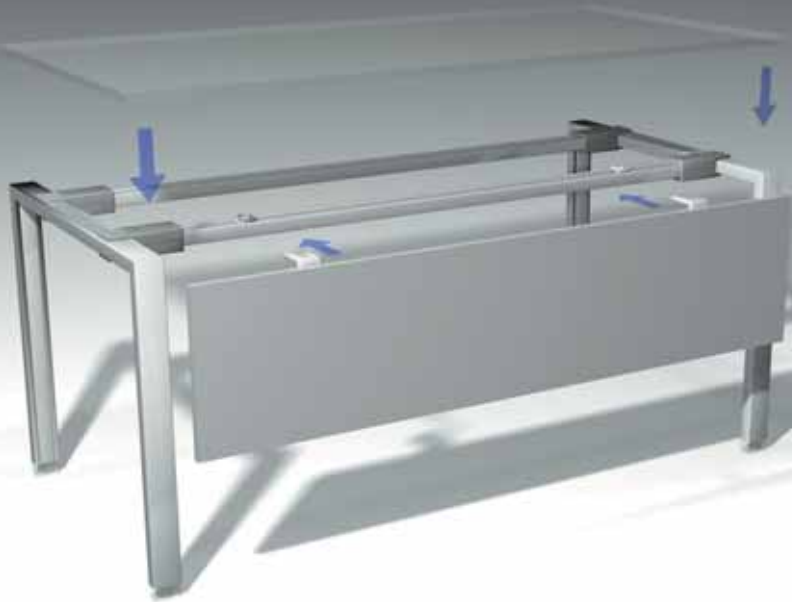

Schema modesty

*Typical configuration
of modesty panel*

*Schéma système de montage
voile de fond*

Esquema faldon

*Montageplan der
Knieraumblende*

6



Schema flip-top

Flip top arrangement

Schéma flip top

Esquema flip-top

Plan Flip-Top

7

Schema braccio
porta-LCD

*Typical configuration
of monitor arm*

*Schéma bras
support écran plat*

Esquema brazo porta lcd

*Montageplan
des LCD-Monitorträgers*



8

Schema lampada-mensola
porta video

*Typical configuration of lamp,
shelf and monitor shelf*

*Schéma système de montage
lampe et tablette support écran*

*Esquema lampara – repisa
portamonitor*

*Montageanleitung der Lampe
und der Monitorträgerplatte*

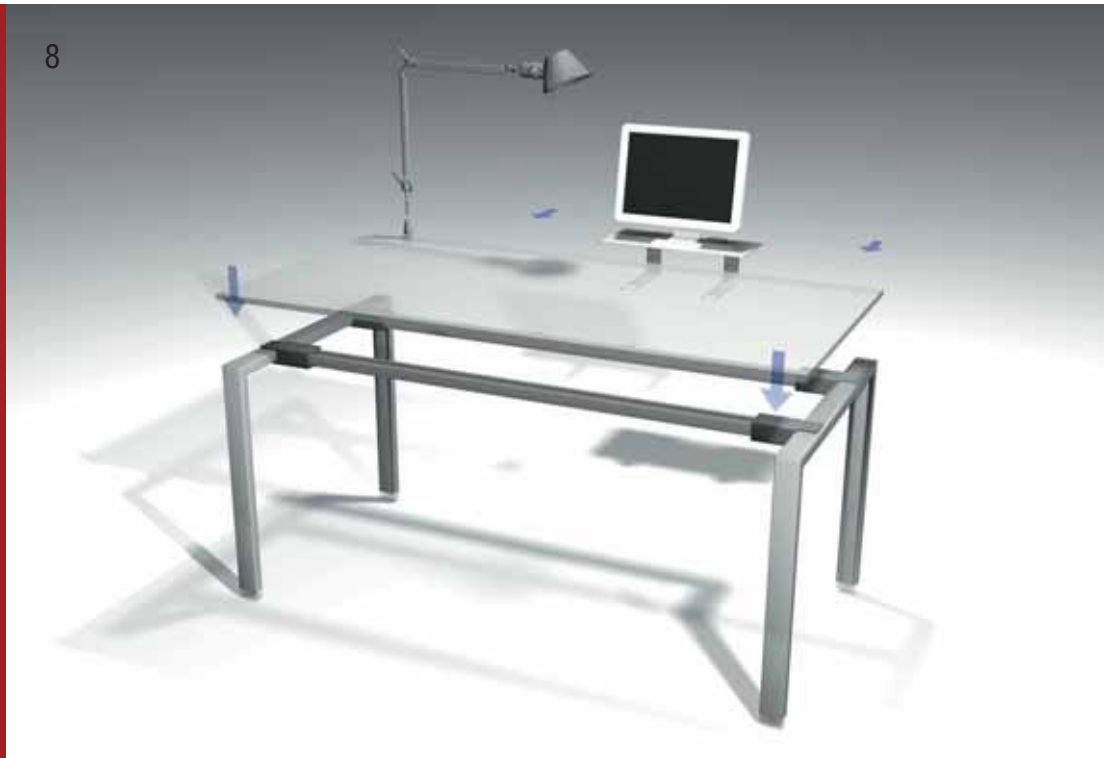

SCRIVANIA SINGOLA (H 73.4) - 28 14/16"

SINGLE DESK - BUREAU SIMPLE - MESA - SCHREIBTISCH

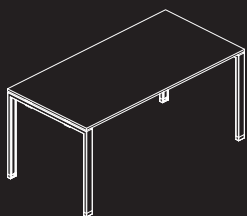

L. 120	47 4/16"	Cod. 0312
140	55 2/16"	Cod. 0314
160	63"	Cod. 0316
180	70 14/16"	Cod. 0318
200	78 12/16"	Cod. 0320

L. 180	70 14/16"	Cod. 0518
200	78 12/16"	Cod. 0520

P. 80 31 8/16" - P.90 35 7/16"

SCRIVANIA DOPPIA CONTRAPPOSTA (H 73.4) - 28 14/16"

FACE-TO-FACE DESKS - BUREAU DOUBLE FACE A FACE
MESA DOBLE CONTRAPUESTA - DOPPELTER SCHREIBTISCH

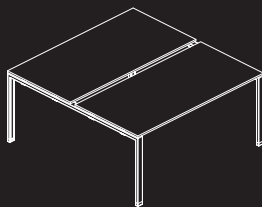

L. 120	47 4/16"	Cod. 1112
140	55 2/16"	Cod. 1114
160	63"	Cod. 1116
180	70 14/16"	Cod. 1118
200	78 12/16"	Cod. 1120

P. 166 65 6/16"

DATTILO INDIPENDENTE (H 73.4) - 28 14/16"

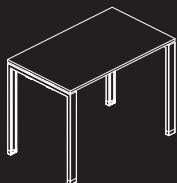

L. 80	31 8/16"	Cod. 0108
100	39 6/16"	Cod. 0110
120	47 4/16"	Cod. 0112

P. 60 23 10/16"

SCRIVANIA SINGOLA CON FLIP-TOP (H 73.4) - 28 14/16"

SINGLE DESK WITH FLIP-TOP - BUREAU SIMPLE AVEC FLIP TOP - MESA CON FLIP-TOP - SCHREIBTISCH MIT FLIP TOP

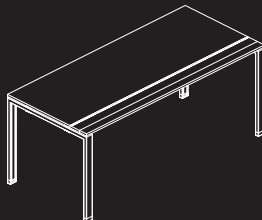

L. 120	47 4/16"	Cod. 3312
140	55 2/16"	Cod. 3314
160	63"	Cod. 3316
180	70 14/16"	Cod. 3318
200	78 12/16"	Cod. 3320

L. 180	70 14/16"	Cod. 3518
200	78 12/16"	Cod. 3520

P. 80 31 8/16" P.90 35 7/16"

SCRIVANIA DOPPIA CONTRAPPOSTA CON FLIP-TOP (H 73.4) - 28 14/16"

FACE-TO-FACE DESKS WITH FLIP-TOP - BUREAU DOUBLE FACE A FACE AVEC FLIP TOP
MESA DOBLE CONTRAPUESTA CON FLIP-TOP - DOPPELTER SCHREIBTISCH MIT FLIP TOP

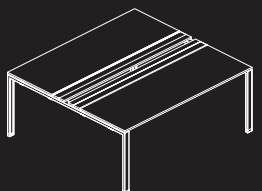

L. 120	47 4/16"	Cod. 3912
140	55 2/16"	Cod. 3914
160	63"	Cod. 3916
180	70 14/16"	Cod. 3918
200	78 12/16"	Cod. 3920

P. 166 65 6/16"

STRUTTURA PER CONDIVISIONE (H 73.4) - 28 14/16"

EXTENDING DESK - STRUCTURE POUR RALLONGE BUREAU SIMPLE
ESTRUCTURA PARA COMPARTIR - VERLAENGERUNG FUER SCHREIBTISCH

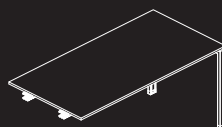

L. 80	31 8/16"	Cod. 1408	L. 180	70 14/16"	Cod. 1818
100	39 6/16"	Cod. 1410	200	78 12/16"	Cod. 1820
120	47 4/16"	Cod. 1412			

L. 120	47 4/16"	Cod. 1612
140	55 2/16"	Cod. 1614
160	63"	Cod. 1616
180	70 14/16"	Cod. 1618
200	78 12/16"	Cod. 1620

P. 60 23 10/16"

P. 80 31 8/16"

P. 90 35 7/16"

STRUTTURA PER CONDIVISIONE DOPPIA (H 73.4) - 28 14/16"

FACE-TO-FACE EXTENDING DESKS - STRUCTURE POUR RALLONGE BUREAU DOUBLE FACE A FACE
ESTRUCTURA DOBLE PARA COMPARTIR - VERLAENGERUNG FUER DOPPELTEN SCHREIBTISCH

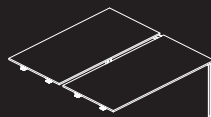

L. 80	31 8/16"	Cod. 2208
100	39 6/16"	Cod. 2210
120	47 4/16"	Cod. 2212

L. 120	47 4/16"	Cod. 2412
140	55 2/16"	Cod. 2414
160	63"	Cod. 2416
180	70 14/16"	Cod. 2418
200	78 12/16"	Cod. 2420

P. 126 49 10/16"

P. 166 65 6/16"

DATTILO AGGANCIATO (H 73.4) - 28 14/16"

SUSPENDED RETURN - RETOUR ACCROCHE - ALA SUSPENDIDA - WINKELANBAUTISCH

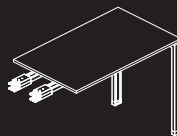

L. 80	31 8/16"	Cod. 1208
100	39 6/16"	Cod. 1210
120	47 4/16"	Cod. 1212

P. 60 23 10/16"

STRUTTURA PER CONDIVISIONE CON FLIP-TOP (H 73.4) - 28 14/16"

EXTENDING DESK WITH FLIP-TOP - STRUCTURE POUR RALLONGE BUREAU SIMPLE AVEC FLIP TOP
ESTRUCTURA PARA COMPARTIR (CON FLIP-TOP) - VERLAENGERUNG FUER SCHREIBTISCH MIT FLIP TOP

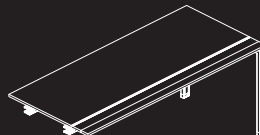

L. 120	47 4/16"	Cod. 4212
140	55 2/16"	Cod. 4214
160	63"	Cod. 4216
180	70 14/16"	Cod. 4218
200	78 12/16"	Cod. 4220

L. 180	70 14/16"	Cod. 4418
200	78 12/16"	Cod. 4420

P. 80 31 8/16" P.90 35 7/16"

STRUTTURA PER CONDIVISIONE DOPPIA CON FLIP-TOP (H 73.4) - 28 14/16"

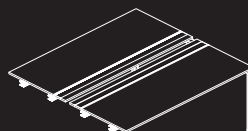

L. 120	47 4/16"	Cod. 4812
140	55 2/16"	Cod. 4814
160	63"	Cod. 4816
180	70 14/16"	Cod. 4818
200	78 12/16"	Cod. 4820

P. 166 65 6/16"

MODESTY PANEL (H 34) - 13 6/16"

MODESTY PANEL - VOILE DE FOND - FALDON - KNIERAUMBLENDE

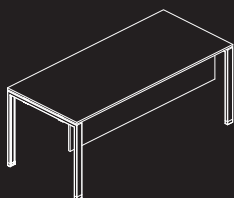

L.	120	47 4/16"	Cod. 9012
	140	55 2/16"	Cod. 9014
	160	63"	Cod. 9016
	180	70 14/16"	Cod. 9018
	200	78 12/16"	Cod. 9020

SCREEN FRONTALE E LATERALE (H 40) - 15 12/16"

FRONTAL AND LATERAL SCREENS - PANNEAU ECRAN FRONTAL - PANEL FRONTAL Y LATERAL - FRONTALPANEEL
Melaminico - Melamines - Mélamines - Melamin - Melamínicos



L.	100	39 6/16"	Cod. 9310
	120	47 4/16"	Cod. 9312
	140	55 2/16"	Cod. 9314
	160	63"	Cod. 9316
	180	70 14/16"	Cod. 9318
	200	78 12/16"	Cod. 9320
L.	60	23 10/16"	Cod. 9606
	80	31 8/16"	Cod. 9608
	90	35 7/16"	Cod. 9609

SCREEN FRONTALE E LATERALE (H 40) - 15 12/16"

FRONTAL AND LATERAL SCREENS - PANNEAU ECRAN FRONTAL - PANEL FRONTAL Y LATERAL - FRONTALPANEEL
Metacrilato - Metacrylate - Méthacrylate - Metakrilat - Metacrilato



L.	100	39 6/16"	Cod. 9410
	120	47 4/16"	Cod. 9412
	140	55 2/16"	Cod. 9414
	160	63"	Cod. 9416
	180	70 14/16"	Cod. 9418
	200	78 12/16"	Cod. 9420
L.	60	23 10/16"	Cod. 9706
	80	31 8/16"	Cod. 9708
	90	35 7/16"	Cod. 9709

PORTA CPU

CPU HOLDER - SUPPORT U.C. - PORTA CPU - CPU HALTER

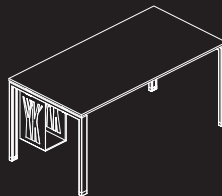

L.	23	9 1/16"	Cod. 9910
P.	28	11"	
H.	50	19 11/16"	

MENSOLA REGGI-MONITOR

SUPPORTING SHELF FOR MONITOR - TABLETTE SUPPORT ECRAN PLAT
REPISA PORTAMONITOR - MONITORHALTERPLATTE

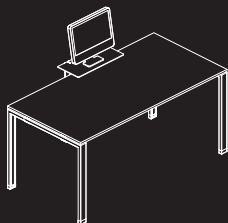

L.	50	19 11/16"	Cod. 9915
P.	23	9 1/16"	
H.	12	4 12/16"	(sopra piano)

BRACCIO PORTA-MONITOR

MONITOR ARM - BRAS SUPPORT ECRAN PLAT - BRAZO PORTAMONITOR - LCD-MONITORTRÄGER

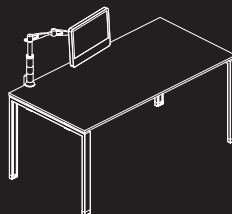

L.	10 - 50	3 15/16"	Cod. 9917
H.	30 - 40	19 11/16"	

TAVOLO RIUNIONE (H 73.4) - 28 14/16"

MEETING TABLE - TABLE DE REUNION - MESA DE JUNTAS - KONFERENZTISCH

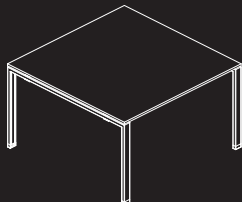

L.	126	49 10/16"	Cod. 5012
----	-----	-----------	-----------

P. 126 49 10/16"

TAVOLO RIUNIONE (H 73.4) - 28 14/16"

MEETING TABLE - TABLE DE REUNION - MESA DE JUNTAS - KONFERENZTISCH

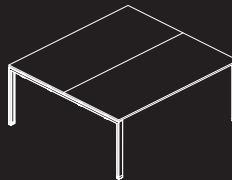

L.	166	65 6/16"	Cod. 5016
----	-----	----------	-----------

P. (83+83) 32 11/16" + 32 11/16"

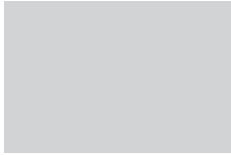
Strutture *Frames Structures Korpus Estructuras*

Grey
Gris
Grau
Gris

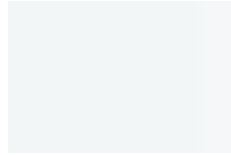

Bianco
White
Blanc
Weiß
Blanco

Melaminici *Melamines Mélaminés Melamin Melamínicos*

Bianco rigato
Rippled effect white
Blanc avec rayures en sérigraphie
Linierte weiß
Blanco rayado



Grigio rigato
Rippled effect grey
Gris avec rayures en sérigraphie
Linierte grau
Gris rayado



Rovere chiaro
Light oak
Chêne clair
Helles Eichenholz
Roble claro



Rovere moro
Dark oak
Chêne foncé
Dunkles Eichenholz
Roble oscuro

Goffrati *Embossed Gaufré Matt Lackiert Lacado*

Goffrato Moka
Embossed Mocha
Gaufré Moka
Matt Lackiert Mokka
Lacado Cafe



Goffrato Indaco
Embossed Indigo
Gaufré Indigo
Matt Lackiert Indigoblau
Lacado Azul Indigo



Goffrato Rubino
Embossed Ruby
Gaufré Rubis
Matt Lackiert Rubinrot
Lacado Rubi



Goffrato Cedro
Embossed Lime green
Gaufré Vert Cédrat
Matt Lackiert Zitronatgrün
Lacado Verde Cedro



Goffrato Argento
Embossed Silver
Gaufré Argent
Matt Lackiert Silber
Lacado Plata



Goffrato bianco
Embossed White
Gaufré blanc
Matt Lackiert Weiss
Lacado blanco



Goffrato nero
Embossed black
Gaufré noir
Matt Lackiert schwarz
Lacado negro

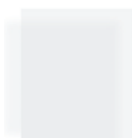

Goffrato rosso "F"
Embossed red "F"
Gaufré rouge "F"
Matt Lackiert Rot "F"
Lacado rojo "F"

Metacrilato *Metacrylate Méthacrylate Metakrilat Metacrilato*

Trasparente
Transparent
Transparent
Durchsichtig
Transparente



Rosso trasparente
Red transparent
Rouge transparent
Durchsichtig rot
Rojo transparente



Bleu trasparente
Blue transparent
Bleu transparent
Durchsichtig blau
Azul transparente



Bianco satinato
Satin-finish white
Blanc satiné
Weiß satinierte
Blanco satinado



Arancione satinato
Satin-finish orange
Orange satiné
Orange satinierte
Naranja satinado



Blu satinato
Satin-finish blue
Bleu satiné
Blau satinierte
Azul satinado



Verde satinato
Satin-finish green
Vert satiné
Grün satinierte
Verde satinado

- **Le finiture contenute nel presente catalogo sono puramente indicative e non sono di riferimento per le forniture del prodotto.**
- Due to the printing process, finishes shown in this catalogue are for illustration only. The finish on the final item may differ slightly from the printed illustration.
- Les finitions contenues dans ce catalogue ne sont pas contractuelles - les photos ne pouvant rendre la parfaite réalité.
- Die Farbwiedergabe dieses Katalogs kann aus drucktechnischen Gründen von den fertigen Produkten abweichen. Ebenso sind technische und konstruktive Änderungen zur Modell-Optimierung möglich.
- Los acabados contenidos en este catálogo son puramente indicativos y no son de referencia para los suministros del producto.

design
Filippon & Mirto Antonel

art direction
Mirto Antonel

foto
Michele Guerra + Kleb Foto & Studio srl
Vigonovo PN - Italy

fotolito
www.graficain.it
Verona - Italy

Foto di Copertina:
"Pegasus" - C. Parada

AA/CABA/AC





ALEA srl - Via Col de Rust, 19 - 33070 Sarone (PN) - ITALIA
Tel. ++39.0434.777333 - Fax ++39.0434.779903
www.aleaoffice.com - e-mail: info@aleaoffice.com

ALEA USA INC. - 3449 NE 1st Avenue, Mews L-32 - Miami FL 33137
Tel. 305 470-1200 - Fax 305 470-9070
www.alea-usa.com - e-mail: info@alea-usa.com

SHOWROOM: **MILANO 20123**
Via Giacomo Leopardi, 12
Tel. 800.081.001

PARIS 75013
Rive Gauche - 24 av. Pierre Mendès France
Tel. +33 (0) 1 43 14 30 75